



<i>Details</i>	<i>Page Number</i>
----------------	------------------------

Austin - Healey Catalogue Index

<i>Index & Original Features</i>	<i>1</i>
<i>Sales Policy</i>	<i>2</i>
<i>Order Form</i>	<i>3</i>
<i>Terms & Conditions</i>	<i>4</i>
<i>Company Information</i>	<i>5</i>
<i>Colour & Trim References</i>	<i>6</i>



<i>BN4 - 4 Seater (To 68,959)</i>	<i>7 - 10</i>
<i>BN4 - 4 Seater (68,960+)</i>	<i>11 - 14</i>

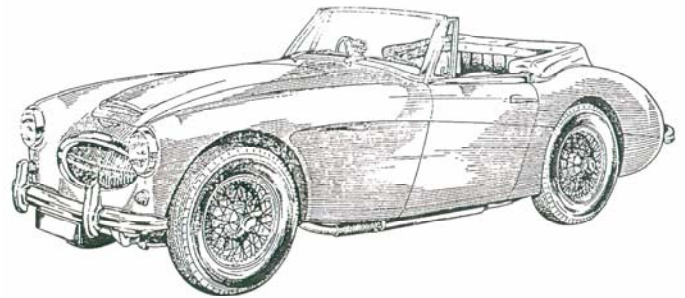

<i>BT7- 4 Seater</i>	<i>15 - 18</i>
----------------------	----------------

<i>BJ7- 4 Seater</i>	<i>19 - 22</i>
----------------------	----------------

Original Features

<i>BJ8- 4 Seater (To 26,704)</i>	<i>23 - 24</i>
<i>BJ8- 4 Seater (26,705+)</i>	<i>25 - 26</i>

<i>Seats & Quarter panels with "heat welded" pattern</i>
<i>Seats & Quarter panels with "heat welded" pattern</i>

<i>Weather Equipment BN1-BJ8</i>	<i>27- 28</i>
----------------------------------	---------------

<i>Trim Fittings BN1-BJ8</i>	<i>29 - 30</i>
------------------------------	----------------

NOTES :

BJ8 vinyl front & rear seat feature original black/silver piping & have small & large squares heat "welded" as original , rear quarter panels feature large squares "welded" as original.

We are always happy to help you decide on the interior colour scheme of your classic car. We can offer advice & supply material and colour samples. (it would help to know the exterior paint colour(s) and the interior colour(s) you prefer). To see a selection of the colours currently available please refer to the Colour & Trim Reference page of this catalogue.

Seat & Carpet Parts : As a manufacturer we are able to make and supply individual seat and carpet parts. But please note that there may be colour differences between your existing parts and the new parts supplied due to the effect of general use, light and aging. Any individual parts ordered will be made to special order.

JOHN SKINNER (MANUFACTURING) LTD, is a recognised supplier of the British Austin-Healey Club.

**World wide Export Service
Request**

Trim Available in Leather & Vinyl

Samples Available on





Sales Policy

Orders / Catalogue & sample requests -

For your convenience you can place orders or request catalogue/samples 24 hours a day using :

- Email....sales@john-skinner.co.uk
- Web site....www.john-skinner.co.uk
- Fax....+44 (0)1285 650013
- Alternatively you can write to us at our postal address.
- Telephone on +44 (0)1285 657410 Monday to Friday between 9.00am and 4.30pm.
- If required we are happy to send you a detailed order confirmation.
- It is the customers responsibility to ensure that the correct parts are ordered, we are happy to help identify incorrect trim items fitted to your car. (In many cases trim items will fit other variations of the same or similar model. e.g. trim panels, seats, hood frames, etc.)
- Unless your order clearly states you require non original parts, your order will be made to the specification set out in our catalogue. Please check as **JOHN SKINNER (MANUFACTURING) LTD,** can not be held responsible for parts incorrectly ordered and supplied.

To help us process your order or catalogue/sample requests promptly please give as many details as possible, including your postal details, telephone, fax, email address, car details including exterior colour and trim colour(s). It is also very important to use our stock codes /descriptions when ordering and confirming colour combinations. (For guidance any samples sent to you will have a description & stock code [eg 99951***] printed on attached label)

There is a minimum order value of £5-00.

Payment -Payment must be made with your order unless you have an authorised credit account.

Recommended payment methods are :

- Credit Card : Visa & Mastercard are accepted. Please ensure your complete card details are given including card number, expiry date & cardholder name and postal address.
- Personal cheque : All personal checks will be cleared before shipment of any order.
- Bank cheque (draft), postal orders or international money orders.
- Direct transfer into our bank account, details as follows :

JOHN SKINNER (MANUFACTURING) LTD,

LLOYDS TSB 130, High St, Cheltenham, GL50 1EW Account No : 1863336 Bank Sort Code : 30-91-87

Shipping- All orders will be shipped promptly (except those paid by personal cheque awaiting clearance) via carrier or post. All overseas shipments will be shipped first class air mail or via shipping agent. Within the EU have a good flexible, economic carrier that offers a 3 to 4 day service. If you require a specific shipping arrangement we please make sure that we are told at the time of order. Customer pays all shipping, insurance, duty and customs costs that may be applicable. For our customers outside Great Britain be sure to check both the regulations governing import duties and restrictions on weight, size and/or merchandise.

Claims- Check all shipments BEFORE you sign for them, should any order arrive damaged, check the contents with the carrier & sign the delivery note giving details of any damaged/missing parts. All claims must be made to the carrier and copied to us. Claims for loss, shortages, errors or damages MUST be made within 3 DAYS of RECEIPT of your order.

Returns-All sales are considered final. Permission must be obtained from **JOHN SKINNER (MANUFACTURING) LTD,** before returning any merchandise. Request for return of merchandise must be made within 10 days of the receipt of order. All returns must include a copy invoice and a returns reference number (Bk **/**) and are subject to :

- A 20% re-stocking charge.
- Any unauthorized returns will not be accepted.
- No returns on special order items unless defective or incorrectly manufactured items have been supplied.
- No claim on any item that has been damaged, cut, glued. All items must be in a re-saleable condition.
- It is important to note that before fitting of any trim part, a visual check of the new part for quality and comparison with the part it will replace is essential, if in doubt contact us for help.

Special Order Items- Please allow 3 to 6 weeks for delivery as these items are generally made for your individual car. There will be no returns of special order items unless defective or incorrectly manufactured items were supplied. A non-refundable deposit of 50% will be required once work has started on a special order item.

Back-Orders- Will be shipped as soon as possible, if no back-order required please inform us at the time of order.

Warranty- All parts are subject to the manufacturers warranty of 6 months, which covers workmanship and materials but does not cover labour or failure of their product as a result of misuse, incorrect installation or failure of related parts, nor would the liability of

JOHN SKINNER (MANUFACTURING) LTD, exceed the cost of the original part.

Prices- All prices are subject to change without prior notification. Where a price increase has occurred, price charged will be that at the date of shipment. Prices exclude VAT (Tax), shipping/handling costs. VAT will be charged at the rate ruling at the date of invoice, anyone claiming VAT free prices or VAT refunds must comply with the relevant VAT & EU rules and regulations.

We are always happy to help you decide on the interior colour scheme of your classic car. We can offer advice & supply material and colour samples. (it would help to know the exterior paint colour(s) and the interior colour(s) you prefer). To see a selection of the colours currently available please refer to the Colour & Trim Reference page of this catalogue.

Seat & Carpet Parts : As a manufacturer we are able to make and supply individual seat and carpet parts. But please note that there may be colour differences between your existing parts and the new parts supplied due to the effect of general use, light and aging. Any individual parts ordered will be made to special order.

JOHN SKINNER (MANUFACTURING) LTD, is a recognised supplier of the British Austin-Healey Club.

**World wide Export Service
Request**

Trim Available in Leather & Vinyl

Samples Available on





TERMS & CONDITIONS

1. All our quotations and all orders accepted by us are subject to these terms of business. In these terms all orders are termed contracts. No contracts are entered into us except upon these terms. We shall not be bound by any terms which are inconsistent with these terms; any Purchaser's order or acceptance which purports to include any inconsistent terms shall be construed as if that term was not included therein and shall be deemed for all purposes to be an order or acceptance incorporating these terms of business. In these terms the expression 'quotations' shall include tenders and the expression 'goods' shall include all equipment and materials supplied by us.
2. No variation of these terms of business or addition thereto shall be effective unless in writing duly signed on our behalf.
3. These terms and all contracts relating to them shall in all respects be construed and governed by English Law and the parties hereby submit to jurisdiction of the English Courts.
4. Quotations are limited to the goods specified therein and are subject to availability of the goods at the time when the order is placed. Unless otherwise specified, a quotation at a fixed price will be subject to withdrawal if any order is not placed within 30 days from the date appearing on the quotation.
5. We reserve the right to take up financial references. Acceptance of any order shall be conditional upon such references being found by us to be satisfactory.
6. Prices are based on the cost of materials, components, accessories, labour, transport, statutory obligations and establishment charges and may be subject to variation if any change in such cost or in currency exchange rates affecting such cost takes place before or during the performance of the contract.
7. Carriage prices are inclusive of all carriage charges but any special despatch arrangements to or from ourselves made at the customer's request will be chargeable.
8. Payment of invoices of approved credit customers shall be due 30 days from date of invoice unless terms are stated on the invoice. If payment is delayed the company reserves the right to charge interest at the rate of 2 ½% per month or part of. The company reserves the right to employ Solicitors and/or Debt Collectors in order to recover the debt. The customer will be liable for all charges incurred by the company in recovering the debt.
9. From the date of despatch from our works or delivery by our own transport (as the case may be) until payment of the whole sum payable under the contract has been received by us, all goods shall be at the sole risk of the Purchaser who shall keep them insured against all risks and shall indemnify us against any depreciation or damage to the goods in the event of such payment not being made.
10. Whenever delivery is made before payment of the whole sum payable under the contract, goods delivered shall, to the extent permitted by the law of the country where the goods are situated after delivery, remain our property until we receive such payment. If such law does not permit us to retain the property in the goods we shall be entitled to the benefit of such rights in respect thereof as such law permits us to retain. The Purchaser shall give us every assistance, and shall procure that any ultimate user of the goods shall give every assistance in taking measures required to protect our right of property or other such rights as aforesaid.
11. All drawings, photographs, illustrations, advertisements, particulars and descriptive matter supplied by us are intended to present a general idea of the goods described therein but are not binding and are subject to change or variation from time to time.
12. Dimensions, weights, colour and performances are not guaranteed but will be within reasonable tolerances.
13. **Colour Variation:**
 - a) On material such as leather, vinyl, leathercloth, carpet, moquette, hardura colour variations can occur between production runs of each material.
 - b) There is often not a perfect colour match between different materials; often it is more an acceptable contrast.
 - c) **Shading:** All pile carpets are liable to shading and the customer is advised to take this into account when choosing the carpet. Therefore, the company will not entertain any claims with respect to shading.
 - d) **Matching:** Carpets cut from more than one roll may vary slightly in colour or pattern. The company reserves the right to supply the customer with the best match obtainable.
14. Despatch and completion times are approximate only and we accept no liability whatever in respect of any delay however caused. Such times shall date from the acceptance by us of a written order and shall be subject to our receiving as and when required all instructions, approved drawings, licences, letters of credit, guarantees, deposits, components to be provided by the Purchaser or his supplier and generally all such information and other assistance as may be necessary to enable the works to be carried out. Within seven days after the date of notification that any goods are ready for despatch, the Purchaser shall take delivery or arrange storage at the risk and cost of the Purchaser and the goods shall thereupon be deemed to have been delivered.
15. We shall be relieved of any obligations incurred under a contract and the Purchaser shall be responsible for any extra costs involved whenever and to the extent that the fulfilment of such obligations is prevented, frustrated or impeded as a consequence of war, civil war, strikes, lockouts, trade disputes, fire, earthquake, statutes or regulations issued by any duly constituted authority or other contingencies beyond our control.
16. If goods in transit within the United Kingdom are damaged or partially lost the Purchaser shall give notice of damage or loss in writing to us within 3 days of receipt of goods and to the carrier at once. If such goods are wholly lost the Purchaser shall give notice of damage or loss in writing to us and to the carrier (if any) within twenty-eight days after the transit began.
17. Cancellations: Cancellations cannot be accepted once goods have been cut or despatched. If the Purchaser proposes any alterations after the contract has been accepted, or is in breach of any term of contract, we shall have the right, inter alia, to charge the Purchaser (in addition to the contract price), the whole of the expenses arising from such proposal or breach, including in particular all extra drawings, surveys, materials, components, accessories, waiting time, together with establishment charges and profit allowances at the rate included in our original price.
18. The Purchaser shall be responsible for providing the necessary facilities and means of unloading goods delivered.
19. Any order placed by a Purchaser shall constitute a representation that the Purchaser has complied with every applicable statute, order, regulation, direction or bye-law and all other lawful requirements of any government or duly constituted authority and that, in particular, the Purchaser has lawfully obtained every necessary licence, permit or consent which may be required in connection with the performance of the contract.
20. Credit is not normally allowed on returned goods, such specific being assessed on its merits. No goods may be returned without our authority that we will accept the returns. Application for return must be made in writing 10 days from date of despatch. Credit if any, would be notified after we have inspected the goods at our works. Unless otherwise agreed by us in writing all such returns must be arranged and transported at the customer's expense. Credit will not be allowed on any goods which have been damaged or cut by the customer or their agents. All goods returned for credit must be in a saleable condition and will be subject to a 20% handling charge.

We are always happy to help you decide on the interior colour scheme of your classic car. We can offer advice & supply material and colour samples. (it would help to know the exterior paint colour(s) and the interior colour(s) you prefer). To see a selection of the colours currently available please refer to the Colour & Trim Reference page of this catalogue.

Seat & Carpet Parts: As a manufacturer we are able to make and supply individual seat and carpet parts. But please note that there may be colour differences between your existing parts and the new parts supplied due to the effect of general use, light and aging. Any individual parts ordered will be made to special order.

JOHN SKINNER (MANUFACTURING) LTD, is a recognised supplier of the British Austin-Healey Club.





Company Information

Thank you for your enquiry, listed below is information which I hope you will find useful and relevant when making the important decision about replacing your classic car interior. Should you require any further information or help, please do not hesitate to contact us.

- Established in 1980 to produce quality interior trim for British classic cars to original specification
- Operated from a large modern factory in the small Cotswold town of Cirencester, situated about 80 miles (130 kilometres) west of London.
- Over the years our reputation is linked with **QUALITY & ORIGINALITY** but also flexible enough to produce that very special one off interior .
- All but a very few items are produced in our own factory by a team of dedicated trimmers and machinists.
- As a specialist trim manufacturer we can offer :
 1. Seat kits which are tailor-made, with all the necessary sewing complete and so are ready to fit. Shape , style and pleats are as original (together with heat embossed patterns on some TR & Austin-Healey models)
 2. Carpet kits professionally made in a wide range of colours and qualities, with heel pads , handbrake covers sewn in and with all originally bound edges complete.
 3. All our trim panel boards are cut on purpose made tooling so ensuring a consistent accurate shape and fit. All mounting holes, slots etc are pre-cut to ensure accurate and trouble free fitting.
 4. We have our own High Frequency Plastic Welding machines, these specialist machines when used with the correct tools heat emboss patterns into trim panels, e.g. the pattern found on many door panels, seat covers etc.
 5. We use only top quality materials, leather, vinyl, leathercloth, carpet, moquette, hardura & headlining .
- We take pride and care in ensuring the best possible colour match between different materials used in our trim products, but it is advisable to order all the parts you require at the same time to avoid any possible colour match problems.
- We are also flexible enough to offer a customer a more individual interior should that be required. Maybe a special colour or special coloured piping, all of this is no problem. It should be also noted that providing we can get the required vinyl it is possible to high frequency weld into any trim items original welded patterns as originally featured on that car.
- It should also be noted that because of the specialist nature of trim manufacture, it is likely that we will manufacture your order specially for your car, this can take 3 to 4 weeks depending upon our work load.
- We ship worldwide by land, sea & air.
- We accept payment by cash, cheque, bank draft , VISA & MASTERCARD
- **JOHN SKINNER (MANUFACTURING) LTD** is a recognised supplier for the British TR & Austin-Healey Clubs, is a long standing member of The Jaguar Specialists Association (This Association is recognised by Jaguar Cars Ltd)

Keeping your Classic in Trim since 1980 Trim & Colour Reference Numbers

We are always happy to help you decide on the interior colour scheme of your classic car. We can offer advice & supply material and colour samples. (it would help to know the exterior paint colour(s) and the interior colour(s) you prefer). To see a selection of the colours currently available please refer to the Colour & Trim Reference page of this catalogue.

Seat & Carpet Parts : As a manufacturer we are able to make and supply individual seat and carpet parts. But please note that there may be colour differences between your existing parts and the new parts supplied due to the effect of general use, light and aging. Any individual parts ordered will be made to special order.

JOHN SKINNER (MANUFACTURING) LTD, is a recognised supplier of the British Austin-Healey Club.

**World wide Export Service
Request**

Trim Available in Leather & Vinyl

Samples Available on





Colour	Leather	Vinyl	L/cloth	Carpet			For	Hoods	
		(Ambla)	(Vynide)	Wool	Classic	Standard	PVC	Duck	Mohair
Black	99951001	99948001	99949001	99950001	99950020	9995021	99954001	99954007	99954009
Black: Print	99951002	99948002	99949002	99950001	99950020	9995021	*	*	*
Red	99951003	99948003	99949003	99950002	99950022	9995017	99954004	*	*
Grey	99951004	99948004	99949004	99950004	*	9995019	99954016	*	*
Stone	99951020	99948005	99949005	99950009	*	9995019	99954002	*	99954020
Doeskin	99951020	99948005	99949005	99950009	*	*	99954002	*	99954020
Shadow :SG	99951006	99948006	99949006	99950005	*	*	*	*	*
Blue :RG	99951006	99948007	99949007	99950005	*	9995014	*	*	*
Light Tan	99951013	99948008	99949008	99950006	*	9995014	99954006	*	99954020
Biscuit	99951013	99948008	99949008	99950006	*	9995016	99954006	*	99954020
				99950003					
New : SG	99951007	99948009	99949009	99950007	99950024	9995015	*	*	*
Tan : RG	99951007	99948010	99949010	99950007	99950024	9995015	*	*	*
Chestnut	99951008	99948011	99949011	99950008	99950024	9995025	99954	*	*
Beige:RG	99951026	99948012	99949012	99950009	*	9995019	99954002	*	99954020
Parchment	99951017	99948013	99949045	99950009	*	9995020	99954005	*	*
Parchment-Jag	999510	99948052	*	99950009	*	*	*	*	*
Old Beige	99951005	99948015	99949015	99950009	*	*	99954002	*	99954020
Old Grey	99951023	99948016	99949016	99950004	*	9995020	99954016	*	*
Cinnamon	99951009	99948017	99949017	99950006	99950024	9995019	*	*	*
				99950007					
Dark Tan	99951025	*	99949018	99950007	99950024	*	*	*	*
Russet Red	99951011	99948019	99949019	99950013	99950023	*	99954014	*	*
Suede Green	99951010	99948020	99949020	99950014	*	*	99954	*	*
Maroon	99951012	99948021	99949021	99950015	*	9995018	99954018	*	*
Saville Grey	99951014	99948022	99949022	99950016	*	*	99954016	*	*
Dark Blue	99951022	99948023	99949023	99950017	99950023	9995022	99954021	*	99954013
Magnolia: Jag	99951015	99948024	99949024	99950009	*	*	*	*	*
Magnolia:RR	99951027	99948029	*	99950009	*	*	*	*	*
Dark Green	99951018	99948025	99949041	99950018	*	9995023	99954017	*	99954033
Midnight Blue	99951019	99948026	99949026	99950017	99950023	9995024	99954021	*	99954013
				99950005					
Bright Red	99951021	99948027	99949043	99950013	99950022	*	99954014	*	*
Dark Beige	99951028	99948028	99949028	99950006	*	*	*	*	*
White	99951	99948046	99949044	*	*	*	99954003	*	*

NOTE :

There are other colours available, samples are available for the following trim materials : Leather, Vinyl, Leathercloth ,Moquette , Hardura : Headlining : Carpet - 3 qualities (some colours only)

Please note that very often we manufacture the trim specially for your classic car

Important

JOHN SKINNER (MANUFACTURING) LTD, cannot Guarantee 100% colour matches to samples supplied or 100% colour match on extra materials or trim ordered after the original order is made. It is strongly recommended that all trim & extra materials are ordered at the same time. For best results send a colour sample for matching & we will supply the best colour match available. When you buy direct from us you are not just buying a part number with no service backup ! you are buying quality trim with help & advice if required

We are always happy to help you decide on the interior colour scheme of your classic car. We can offer advice & supply material and colour samples. (it would help to know the exterior paint colour(s) and the interior colour(s) you prefer). To see a selection of the colours currently available please refer to the Colour & Trim Reference page of this catalogue.

Seat & Carpet Parts : As a manufacturer we are able to make and supply individual seat and carpet parts. But please note that there may be colour differences between your existing parts and the new parts supplied due to the effect of general use, light and aging. Any individual parts ordered will be made to special order.

JOHN SKINNER (MANUFACTURING) LTD, is a recognised supplier of the British Austin-Healey Club.

**World wide Export Service
Request**

Trim Available in Leather & Vinyl

Samples Available on



BN4 - 4 Seater (To 68,959)

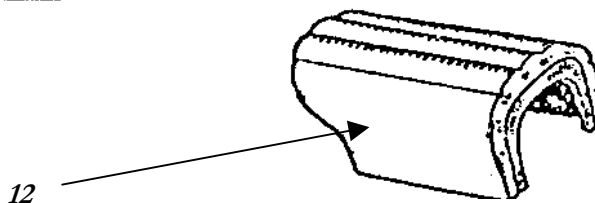
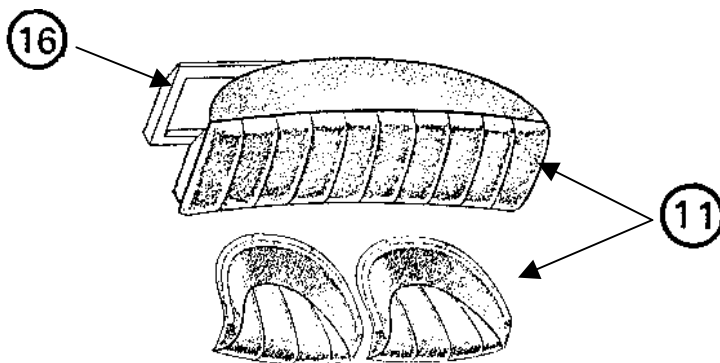
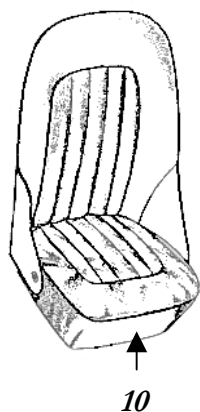
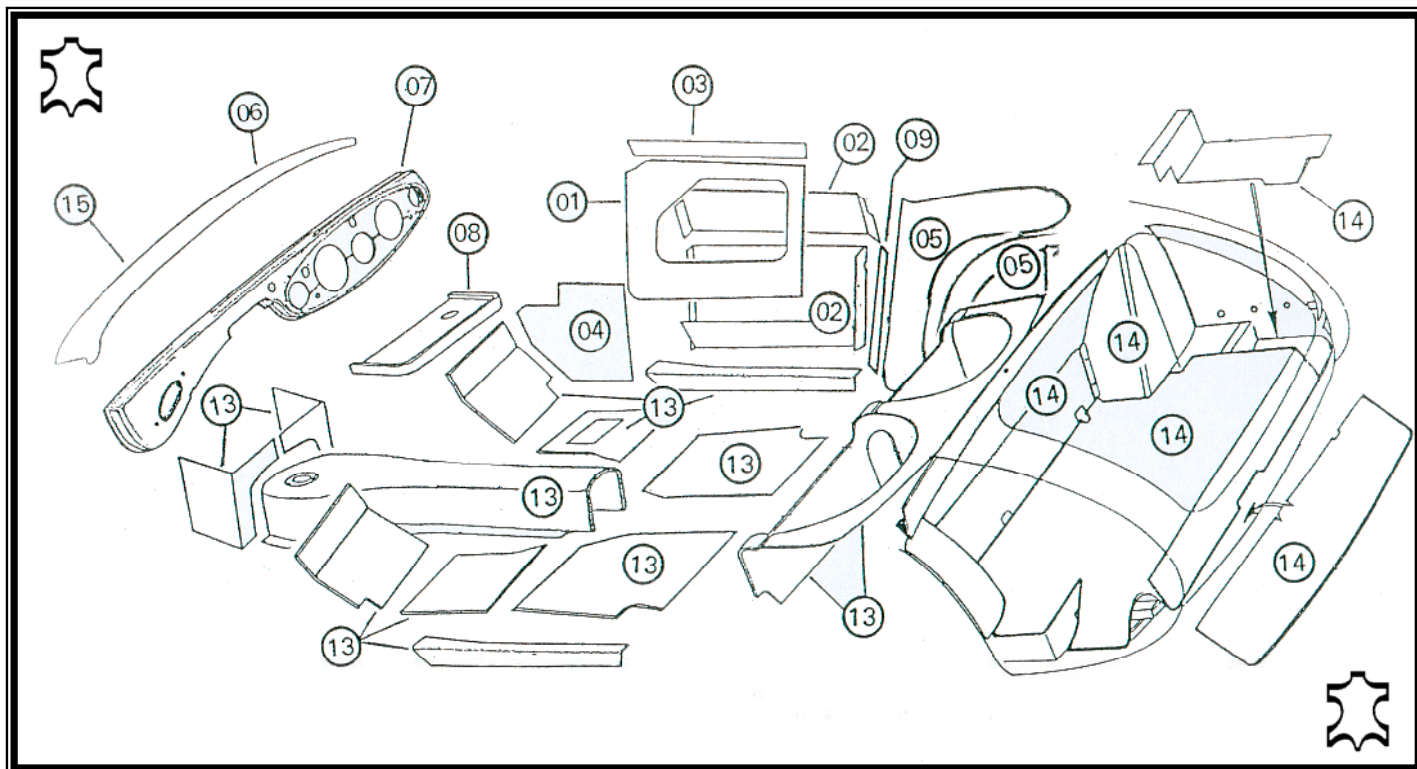

We are always happy to help you decide on the interior colour scheme of your classic car. We can offer advice & supply material and colour samples. (it would help to know the exterior paint colour(s) and the interior colour(s) you prefer). To see a selection of the colours currently available please refer to the Colour & Trim Reference page of this catalogue.

Seat & Carpet Parts: As a manufacturer we are able to make and supply individual seat and carpet parts. But please note that there may be colour differences between your existing parts and the new parts supplied due to the effect of general use, light and aging. Any individual parts ordered will be made to special order.

JOHN SKINNER (MANUFACTURING) LTD, is a recognised supplier of the British Austin-Healey Club.

World wide Export Service Request

Trim Available in Leather & Vinyl

Samples Available on



BN4 - 4 Seater (To 68,959)

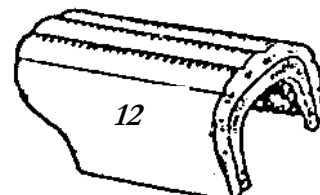
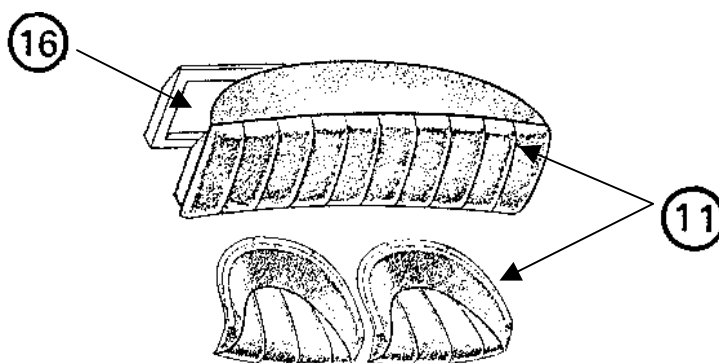
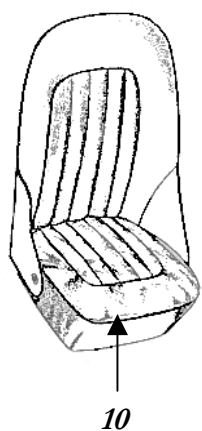
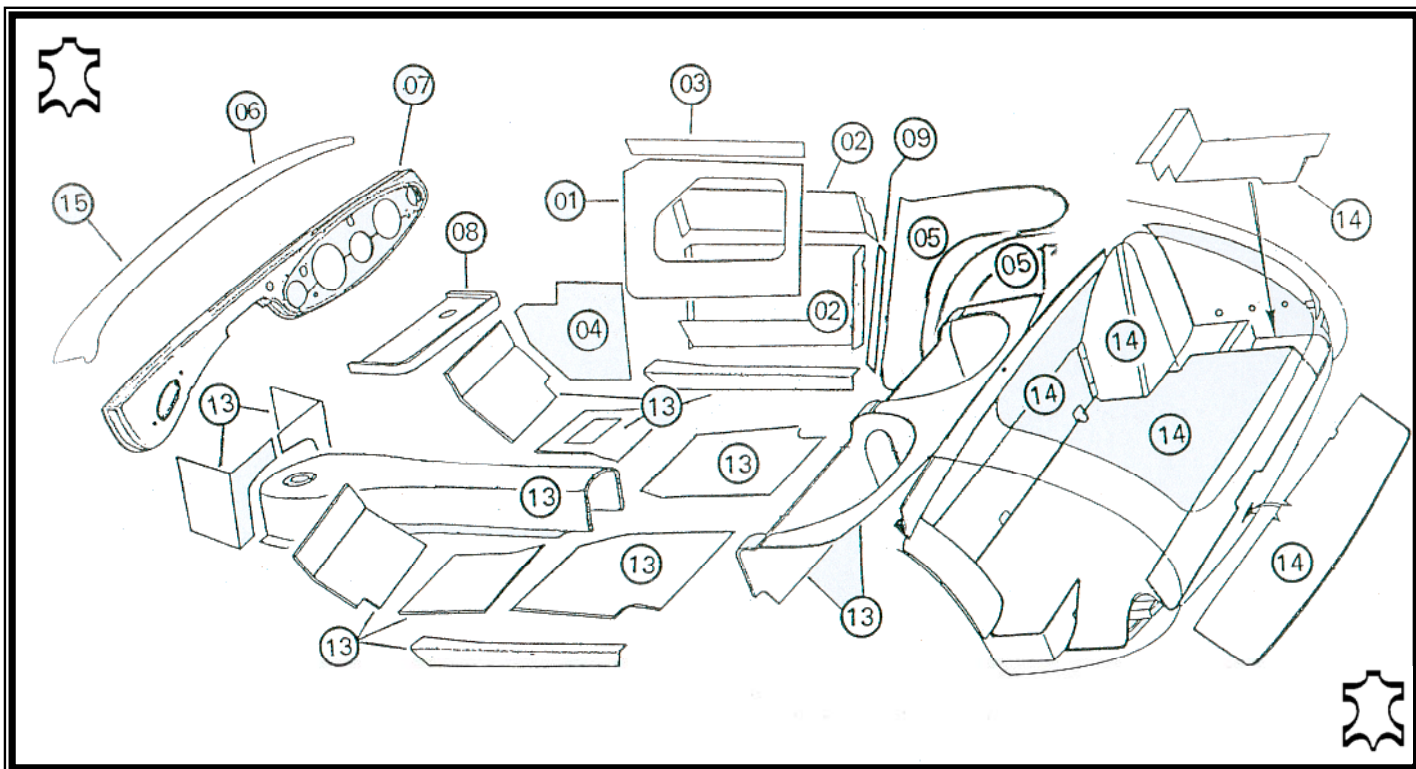

We are always happy to help you decide on the interior colour scheme of your classic car. We can offer advice & supply material and colour samples. (it would help to know the exterior paint colour(s) and the interior colour(s) you prefer). To see a selection of the colours currently available please refer to the Colour & Trim Reference page of this catalogue.

Seat & Carpet Parts: As a manufacturer we are able to make and supply individual seat and carpet parts. But please note that there may be colour differences between your existing parts and the new parts supplied due to the effect of general use, light and aging. Any individual parts ordered will be made to special order.

JOHN SKINNER (MANUFACTURING) LTD, is a recognised supplier of the British Austin-Healey Club.

World wide Export Service
Request

Trim Available in Leather & Vinyl

Samples Available on



BN4 - 4 Seater (From 68,960)

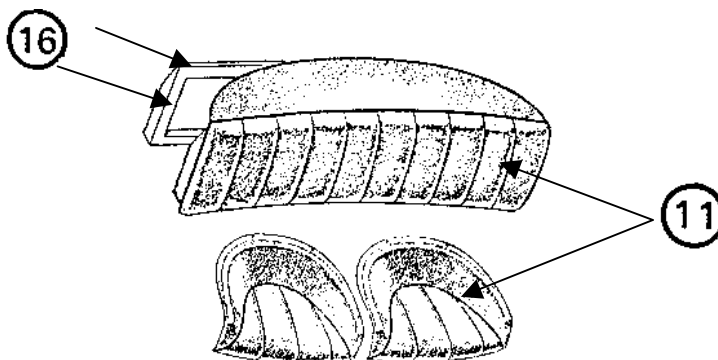
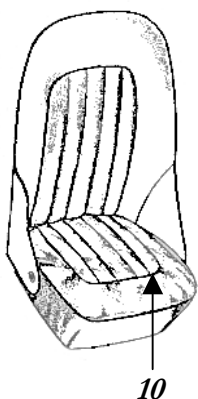
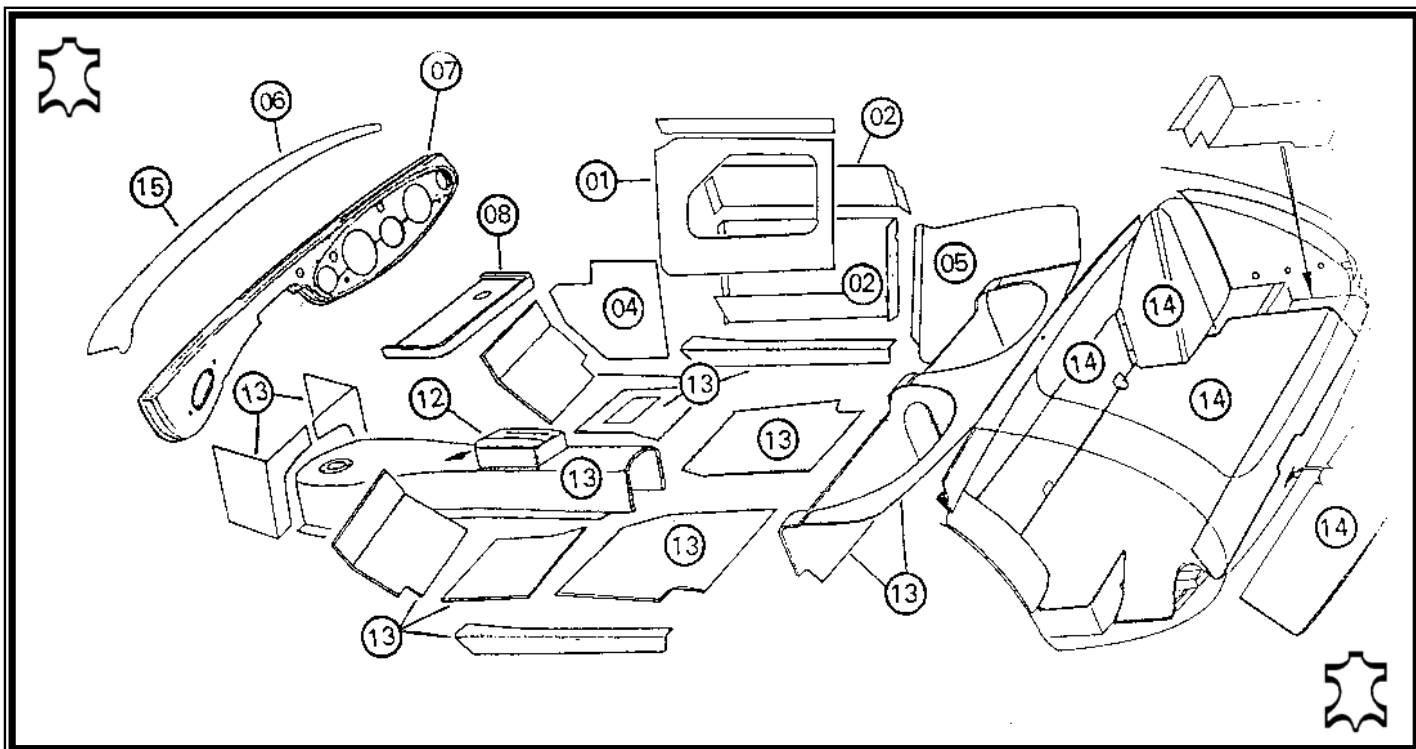

We are always happy to help you decide on the interior colour scheme of your classic car. We can offer advice & supply material and colour samples. (it would help to know the exterior paint colour(s) and the interior colour(s) you prefer). To see a selection of the colours currently available please refer to the Colour & Trim Reference page of this catalogue.

Seat & Carpet Parts: As a manufacturer we are able to make and supply individual seat and carpet parts. But please note that there may be colour differences between your existing parts and the new parts supplied due to the effect of general use, light and aging. Any individual parts ordered will be made to special order.

JOHN SKINNER (MANUFACTURING) LTD, is a recognised supplier of the British Austin-Healey Club.

World wide Export Service
Request

Trim Available in Leather & Vinyl

Samples Available on



BN4 - 4 Seater (From 68,960)

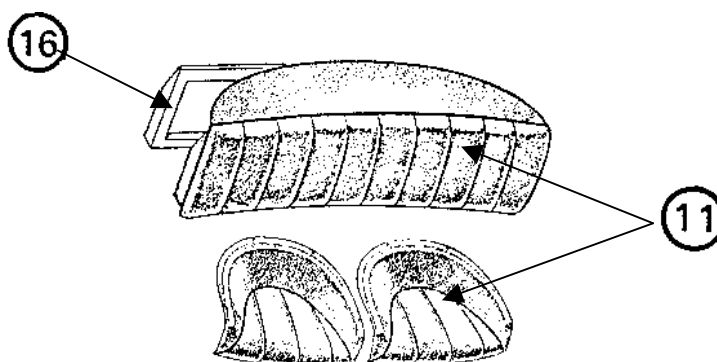
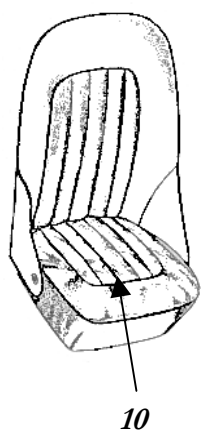
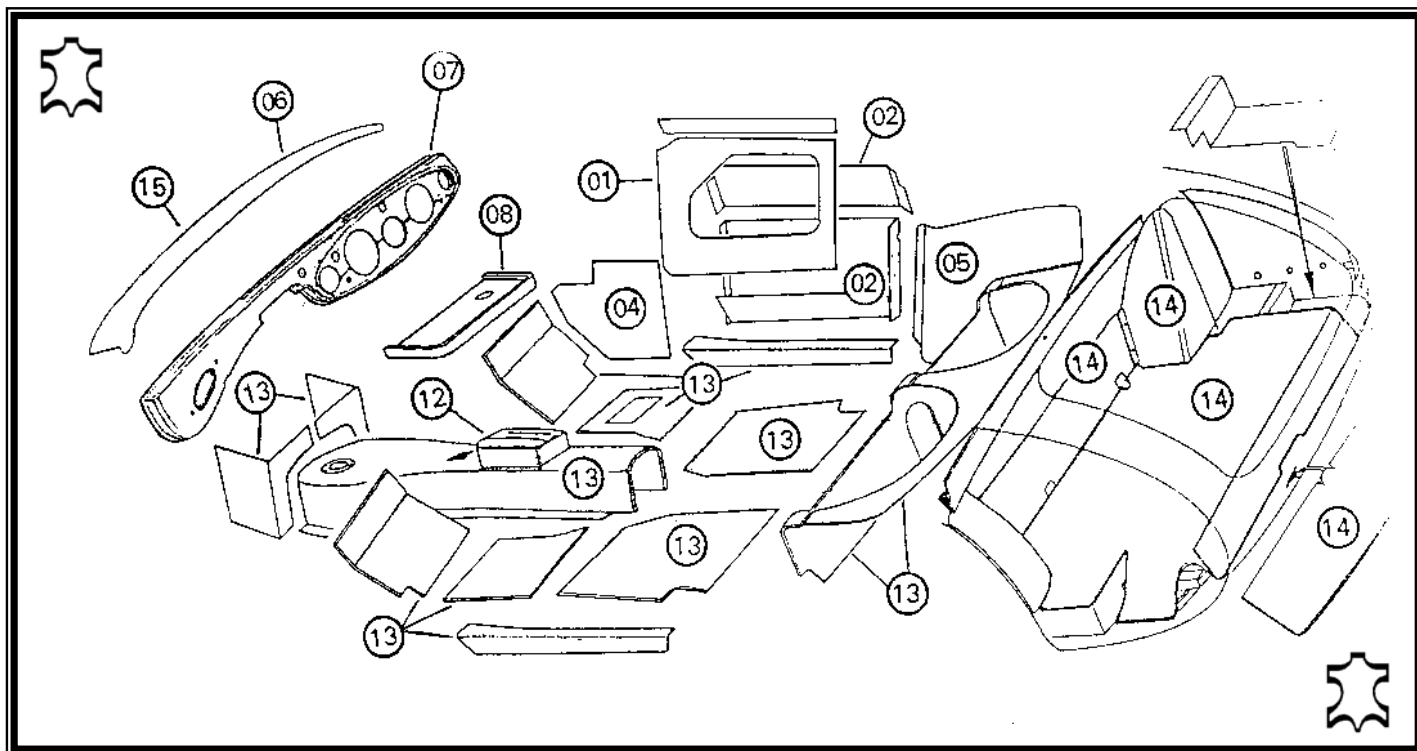

We are always happy to help you decide on the interior colour scheme of your classic car. We can offer advice & supply material and colour samples. (it would help to know the exterior paint colour(s) and the interior colour(s) you prefer). To see a selection of the colours currently available please refer to the Colour & Trim Reference page of this catalogue.

Seat & Carpet Parts: As a manufacturer we are able to make and supply individual seat and carpet parts. But please note that there may be colour differences between your existing parts and the new parts supplied due to the effect of general use, light and aging. Any individual parts ordered will be made to special order.

JOHN SKINNER (MANUFACTURING) LTD, is a recognised supplier of the British Austin-Healey Club.

World wide Export Service Request

Trim Available in Leather & Vinyl

Samples Available on



BT7 - 4 seater

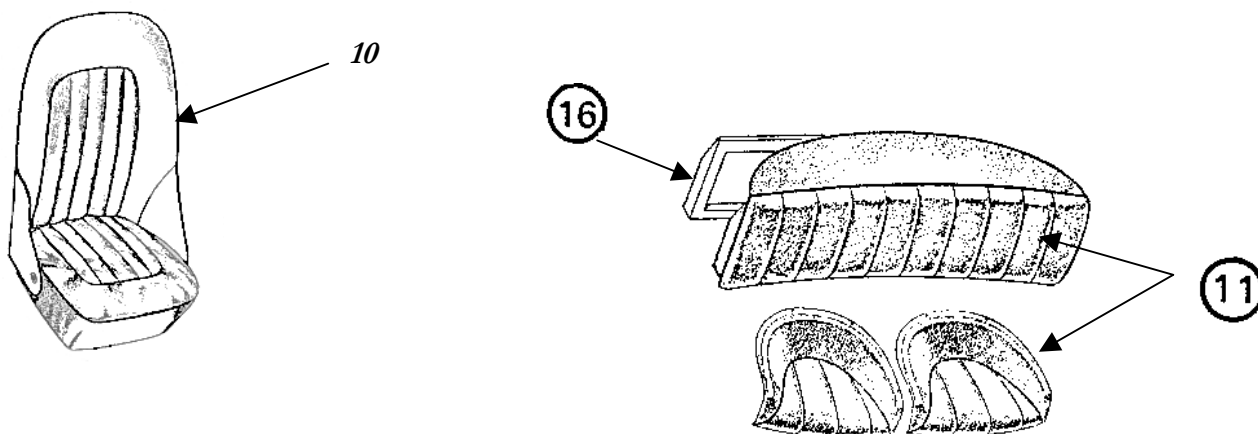
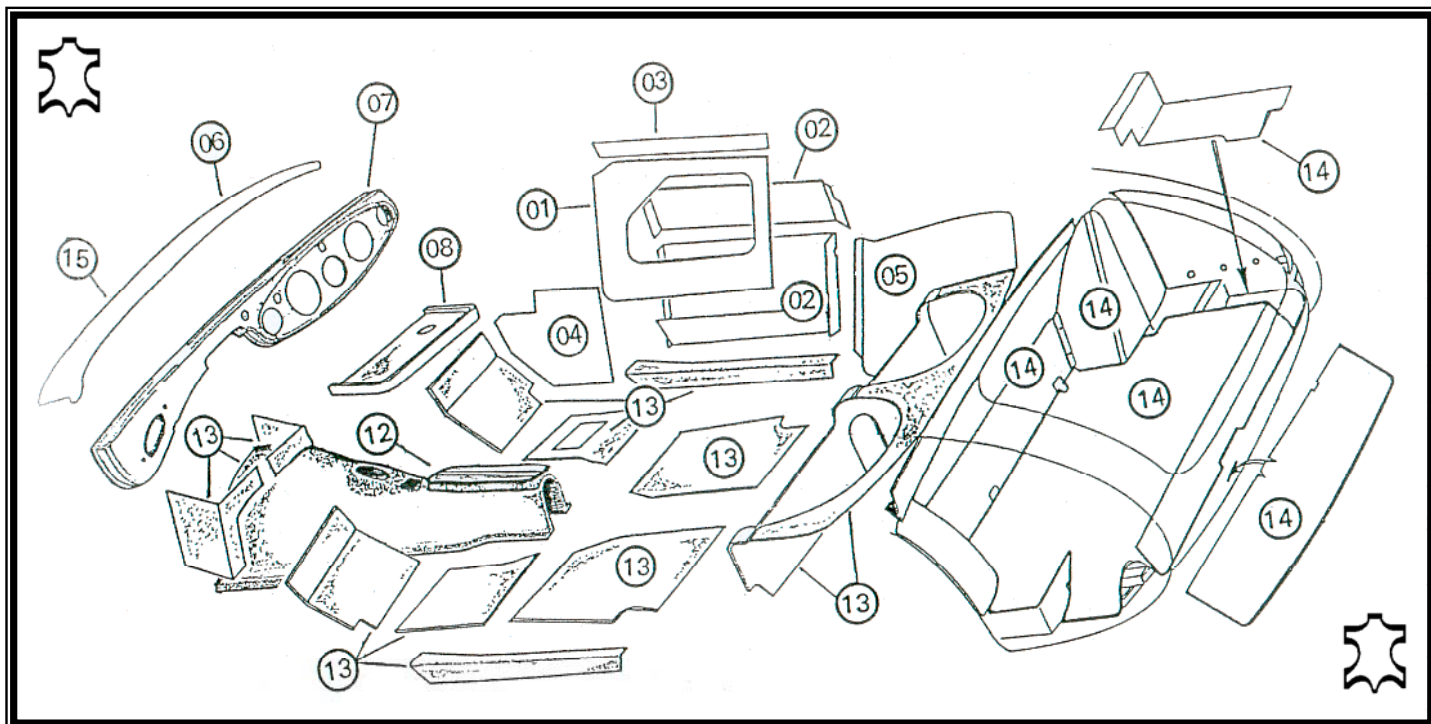

We are always happy to help you decide on the interior colour scheme of your classic car. We can offer advice & supply material and colour samples. (it would help to know the exterior paint colour(s) and the interior colour(s) you prefer). To see a selection of the colours currently available please refer to the Colour & Trim Reference page of this catalogue.

Seat & Carpet Parts: As a manufacturer we are able to make and supply individual seat and carpet parts. But please note that there may be colour differences between your existing parts and the new parts supplied due to the effect of general use, light and aging. Any individual parts ordered will be made to special order.

JOHN SKINNER (MANUFACTURING) LTD, is a recognised supplier of the British Austin-Healey Club.

World wide Export Service Request

Trim Available in Leather & Vinyl

Samples Available on





BT7 - 4 seater

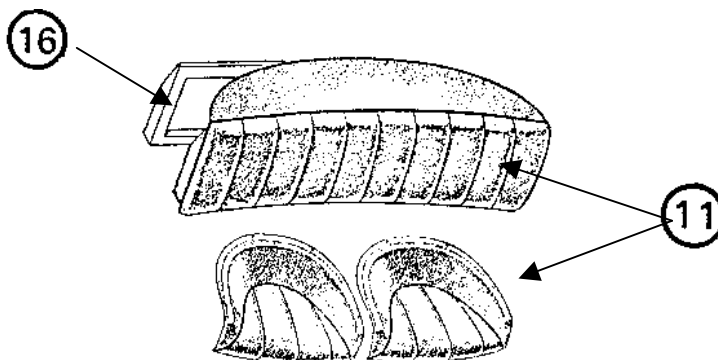
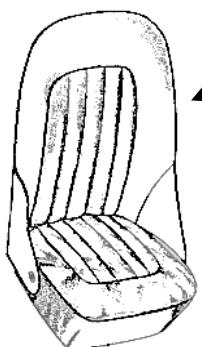
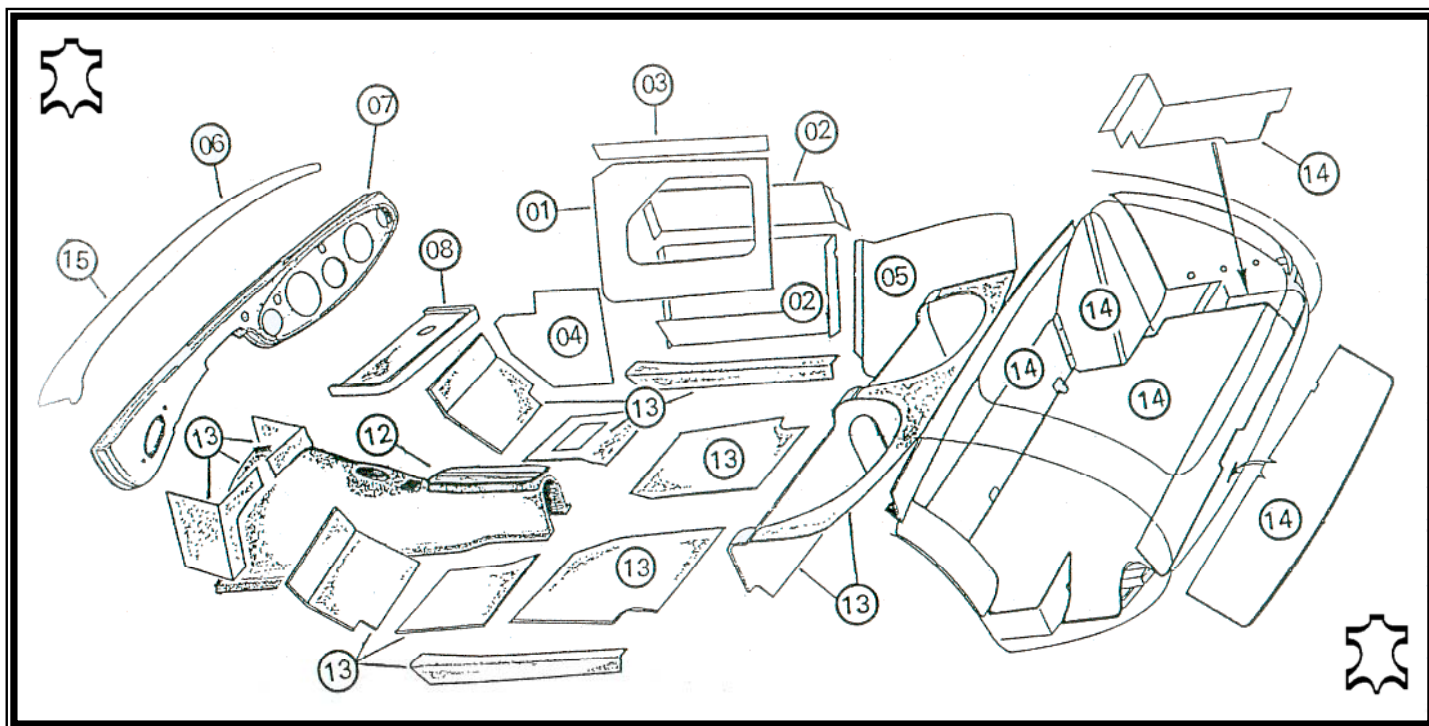

We are always happy to help you decide on the interior colour scheme of your classic car. We can offer advice & supply material and colour samples. (it would help to know the exterior paint colour(s) and the interior colour(s) you prefer). To see a selection of the colours currently available please refer to the Colour & Trim Reference page of this catalogue.

Seat & Carpet Parts: As a manufacturer we are able to make and supply individual seat and carpet parts. But please note that there may be colour differences between your existing parts and the new parts supplied due to the effect of general use, light and aging. Any individual parts ordered will be made to special order.

JOHN SKINNER (MANUFACTURING) LTD, is a recognised supplier of the British Austin-Healey Club.

**World wide Export Service
Request**

Trim Available in Leather & Vinyl

Samples Available on



BJ7- 4 Seater

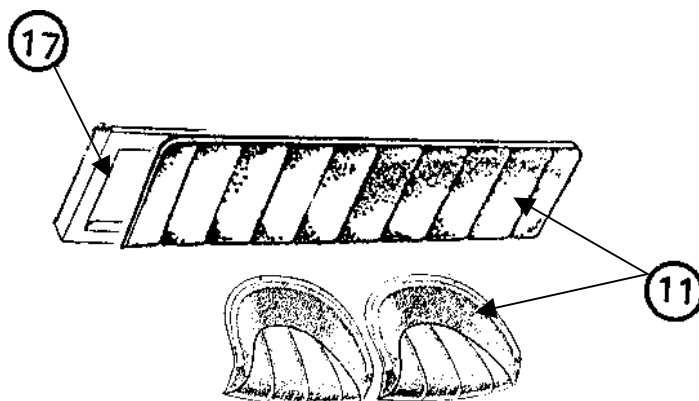
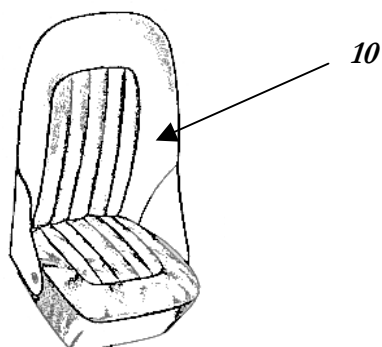
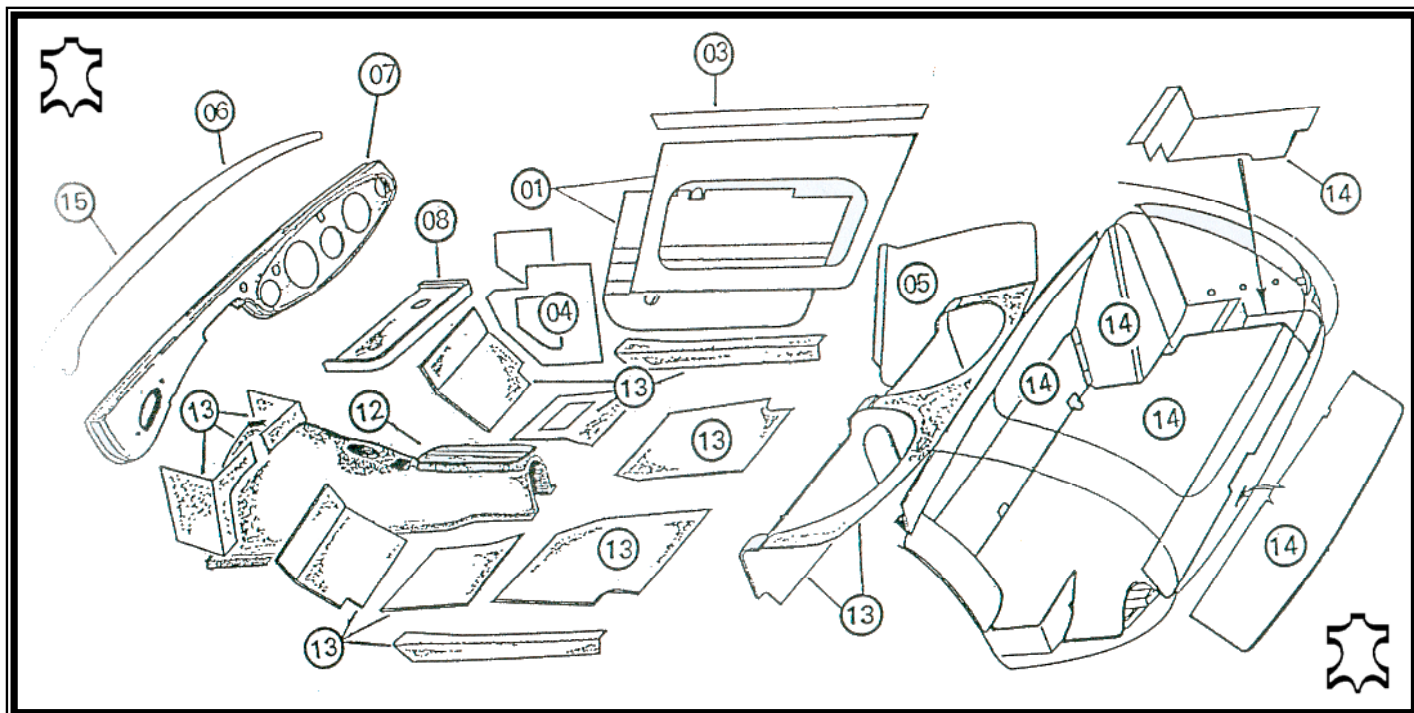

We are always happy to help you decide on the interior colour scheme of your classic car. We can offer advice & supply material and colour samples. (it would help to know the exterior paint colour(s) and the interior colour(s) you prefer). To see a selection of the colours currently available please refer to the Colour & Trim Reference page of this catalogue.

Seat & Carpet Parts: As a manufacturer we are able to make and supply individual seat and carpet parts. But please note that there may be colour differences between your existing parts and the new parts supplied due to the effect of general use, light and aging. Any individual parts ordered will be made to special order.

JOHN SKINNER (MANUFACTURING) LTD, is a recognised supplier of the British Austin-Healey Club.

World wide Export Service Request

Trim Available in Leather & Vinyl

Samples Available on





BJ7- 4 Seater

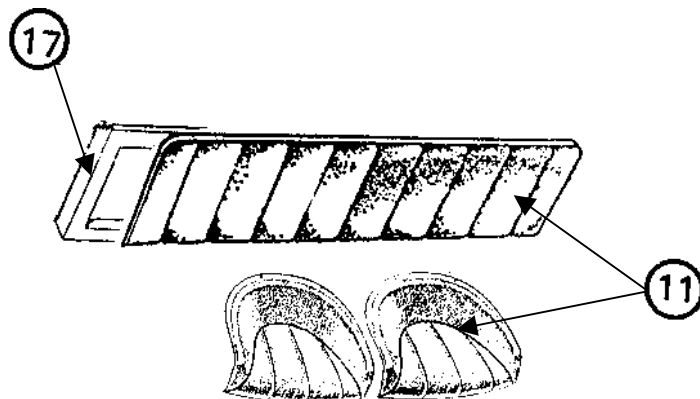
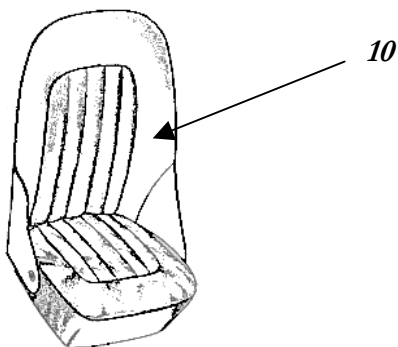
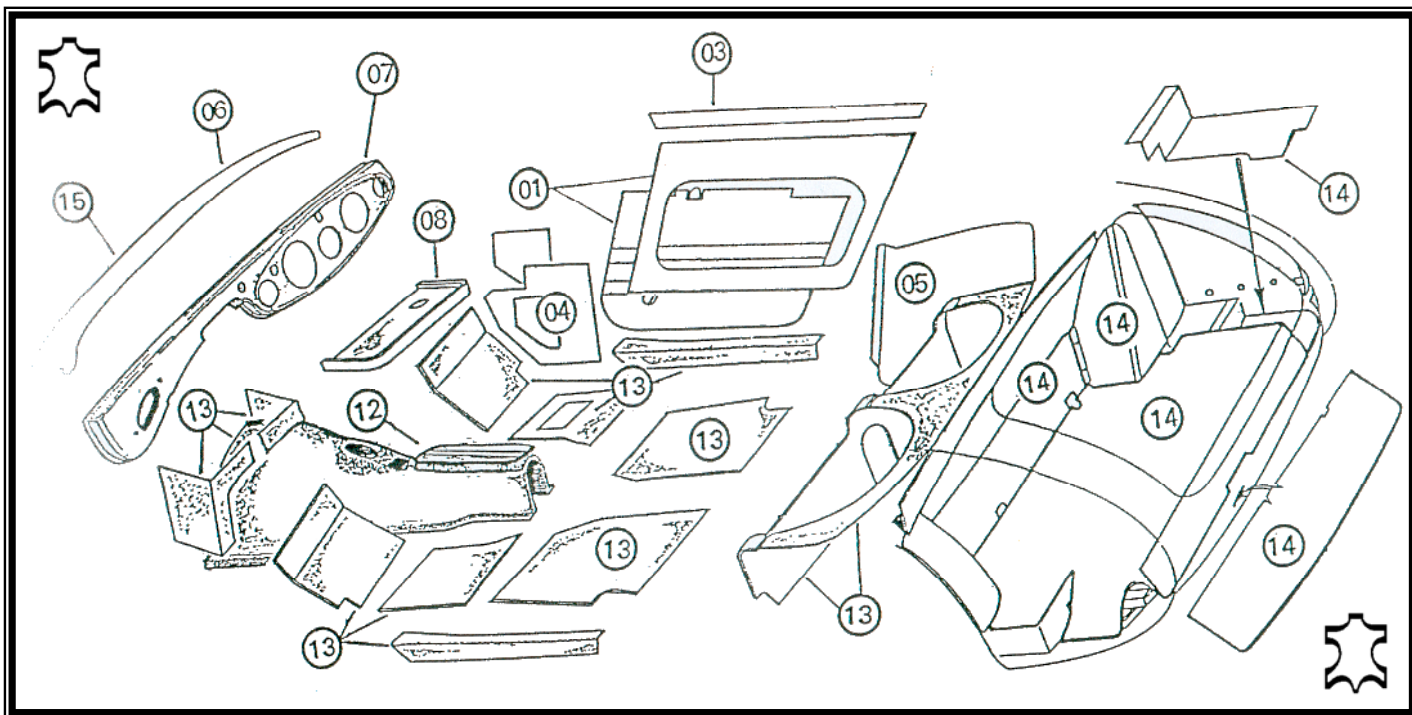

We are always happy to help you decide on the interior colour scheme of your classic car. We can offer advice & supply material and colour samples. (it would help to know the exterior paint colour(s) and the interior colour(s) you prefer). To see a selection of the colours currently available please refer to the Colour & Trim Reference page of this catalogue.

Seat & Carpet Parts: As a manufacturer we are able to make and supply individual seat and carpet parts. But please note that there may be colour differences between your existing parts and the new parts supplied due to the effect of general use, light and aging. Any individual parts ordered will be made to special order.

JOHN SKINNER (MANUFACTURING) LTD, is a recognised supplier of the British Austin-Healey Club.

**World wide Export Service
Request**

Trim Available in Leather & Vinyl

Samples Available on





BJ8 (To 26,704)

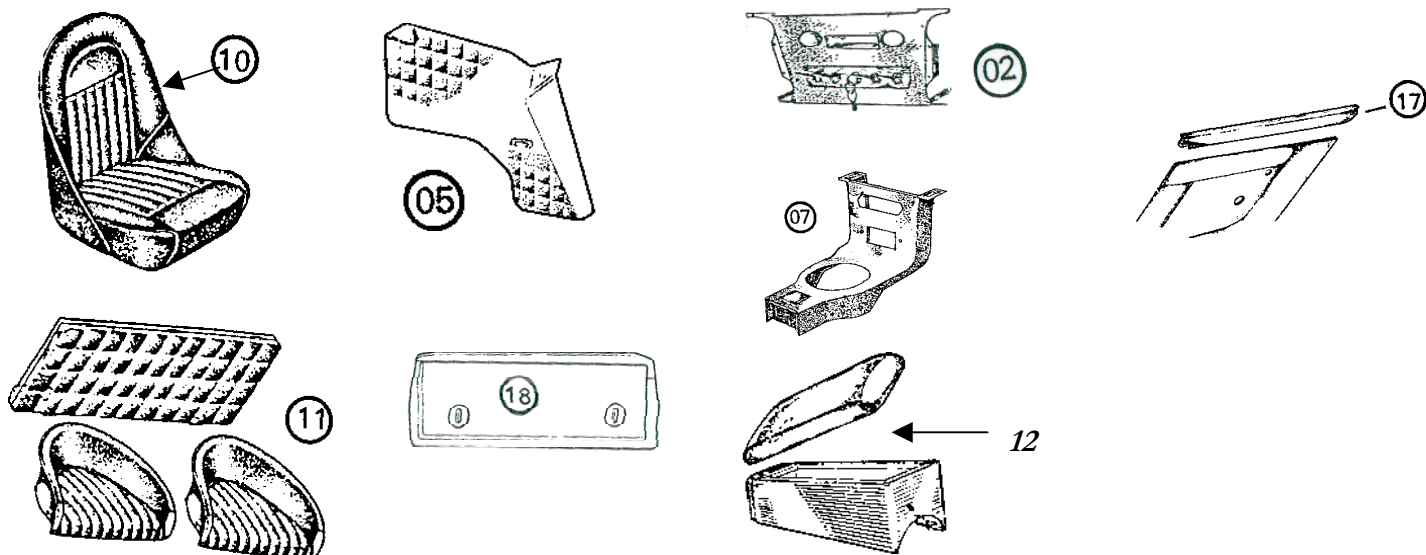
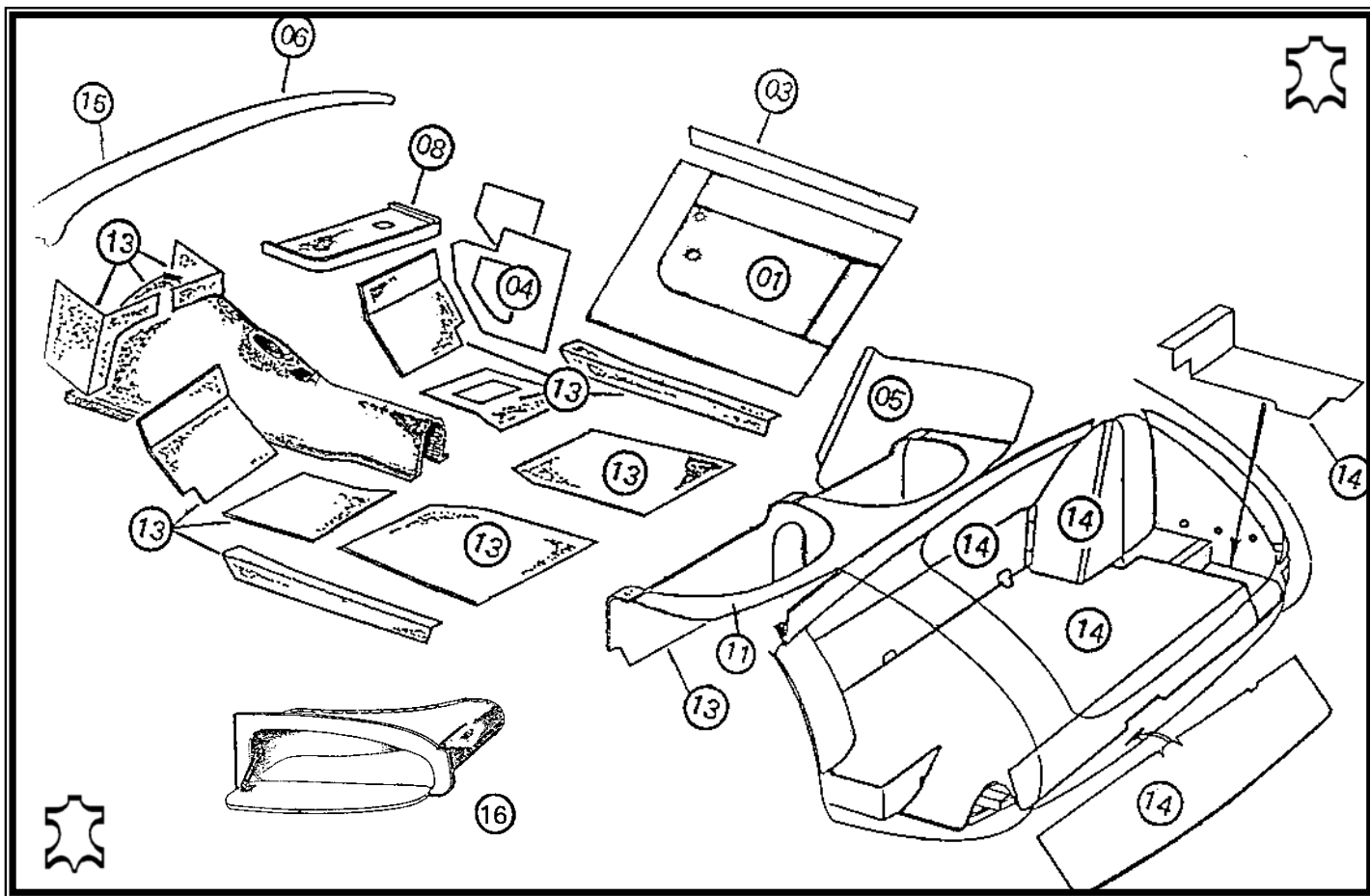

We are always happy to help you decide on the interior colour scheme of your classic car. We can offer advice & supply material and colour samples. (it would help to know the exterior paint colour(s) and the interior colour(s) you prefer). To see a selection of the colours currently available please refer to the Colour & Trim Reference page of this catalogue.

Seat & Carpet Parts: As a manufacturer we are able to make and supply individual seat and carpet parts. But please note that there may be colour differences between your existing parts and the new parts supplied due to the effect of general use, light and aging. Any individual parts ordered will be made to special order.

JOHN SKINNER (MANUFACTURING) LTD, is a recognised supplier of the British Austin-Healey Club.

**World wide Export Service
Request**

Trim Available in Leather & Vinyl

Samples Available on



BJ8 (From 26,705)

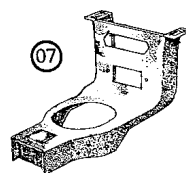
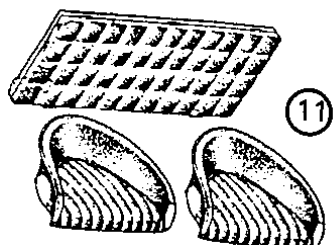
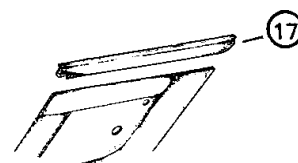
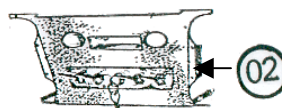
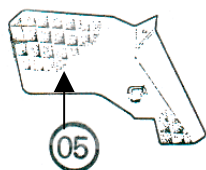
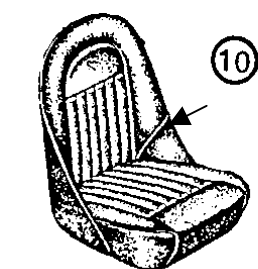
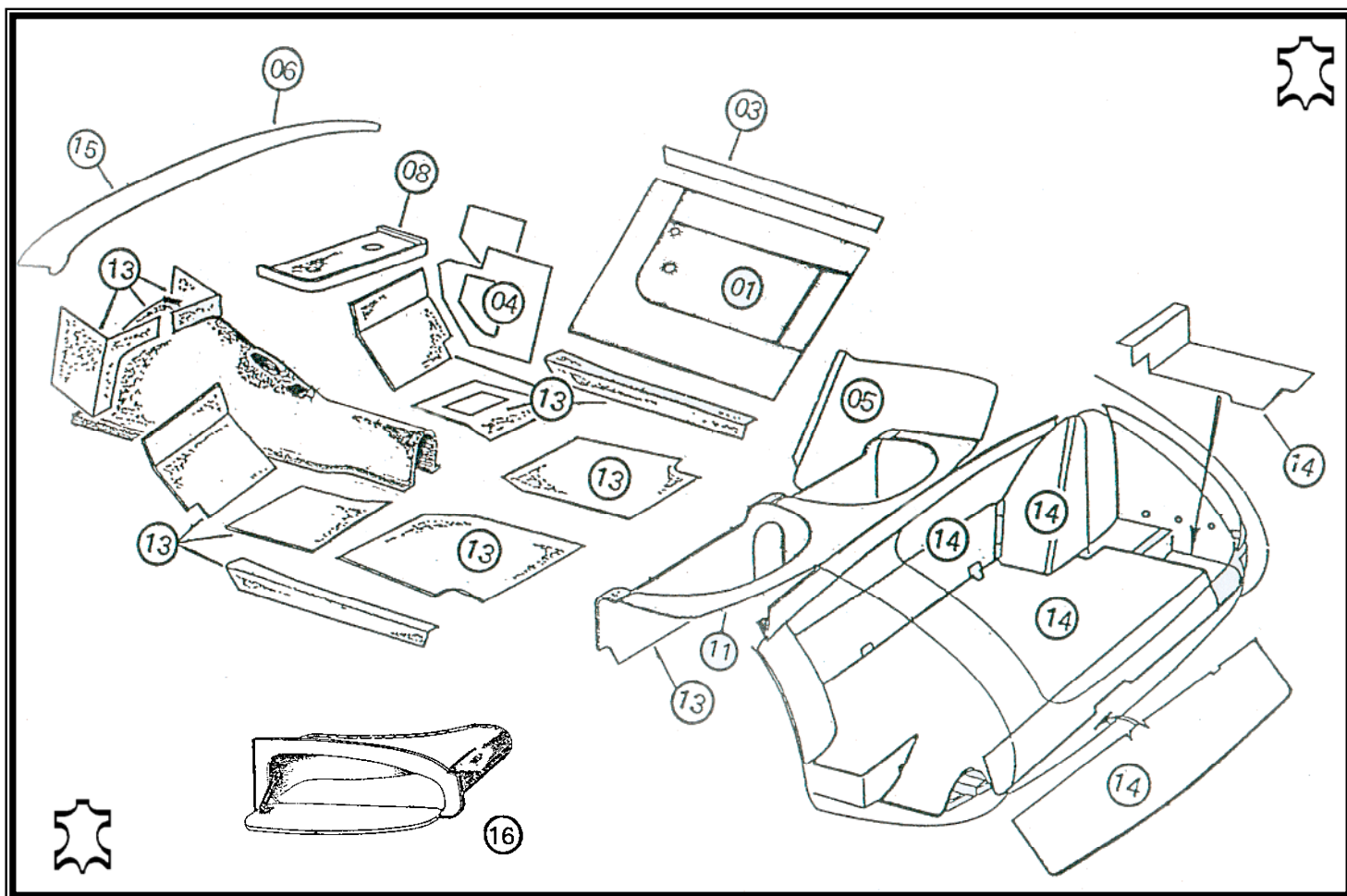

We are always happy to help you decide on the interior colour scheme of your classic car. We can offer advice & supply material and colour samples. (it would help to know the exterior paint colour(s) and the interior colour(s) you prefer). To see a selection of the colours currently available please refer to the Colour & Trim Reference page of this catalogue.

Seat & Carpet Parts: As a manufacturer we are able to make and supply individual seat and carpet parts. But please note that there may be colour differences between your existing parts and the new parts supplied due to the effect of general use, light and aging. Any individual parts ordered will be made to special order.

JOHN SKINNER (MANUFACTURING) LTD, is a recognised supplier of the British Austin-Healey Club.

World wide Export Service
 Request

Trim Available in Leather & Vinyl

Samples Available on





Weather Equipment BN1 to BJ8

01

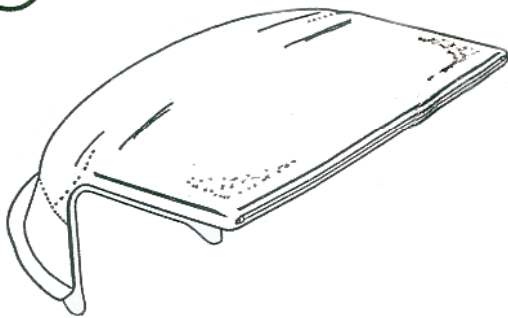

06

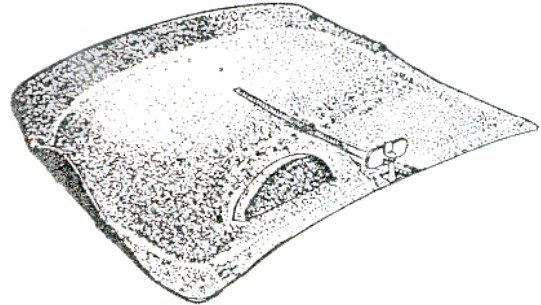

02

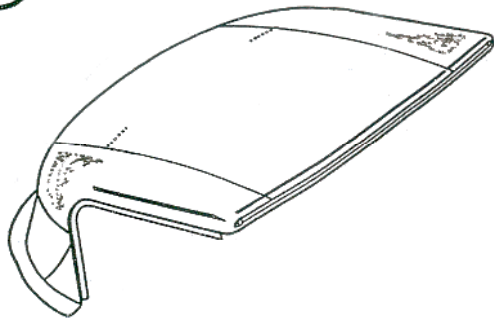

07

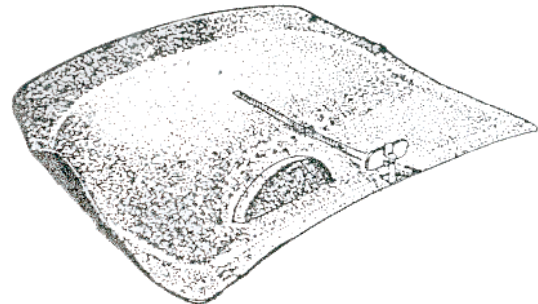

03

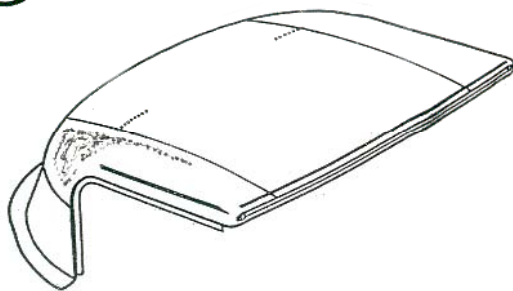

09

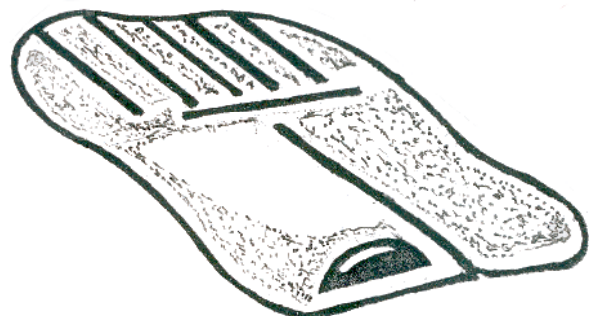

Keeping your Classic Car in Trim since 1980

Keeping your Classic Car in Trim since 1980

We are always happy to help you decide on the interior colour scheme of your classic car. We can offer advice & supply material and colour samples. (it would help to know the exterior paint colour(s) and the interior colour(s) you prefer). To see a selection of the colours currently available please refer to the Colour & Trim Reference page of this catalogue.

Seat & Carpet Parts: As a manufacturer we are able to make and supply individual seat and carpet parts. But please note that there may be colour differences between your existing parts and the new parts supplied due to the effect of general use, light and aging. Any individual parts ordered will be made to special order.

JOHN SKINNER (MANUFACTURING) LTD, is a recognised supplier of the British Austin-Healey Club.

**World wide Export Service
Request**

Trim Available in Leather & Vinyl

Samples Available on





Weather Equipment BN1 to BJ8

Ref No	Description	Trim Colour	Black	Red	Blue	Grey* (Beige)	Lt Tan	Special *State Colour*
02	Hood: BN4 [to 68959]		653101	653102	653103	653104		653109
03	Hood: BN4 [68960 +] & BT7		653120	653121	653122	653123		653129
05	Hood: BJ7 & BJ8 [zip out window]		703101	703102	703103	703104	703105	703109
02	Hood - Duck: BN4 [to 68959]		653110					
03	Hood - Duck: BN4 [68960 +] & BT7		653130					
05	Hood - Duck: BJ7 & BJ8 [zip out window]		703110					
02	Hood - Mohair: BN4 [to 68959]		653114		653115	653116		
03	Hood - Mohair: BN4 [68960 +] & BT7		653134		653135	653136		
05	Hood - Mohair: BJ7 & BJ8 [zip out window]		703114		703115	703116		
07	Tonneau: RHD: BN4 [to 68959]		653140	653141	653142	653143		653149
09	Tonneau: RHD: BN4 [68960 +] & BT7		653178	653179	653180	653181		653182
10	Tonneau: RHD: BJ7 & BJ8 [zip out window]		703120	703121	703122	703123	703124	703129
07	Tonneau: RHD: Duck - BN4 [to 68959]		653160					
09	Tonneau: RHD: Duck - BN4 [68960 +] & BT7		653188					
10	Tonneau: RHD: BJ7 & BJ8 [zip out window]		703140					
07	Tonneau: RHD: Mohair - BN4 [to 68959]		653164		653165	653166		
09	Tonneau: RHD: Mohair - BN4 [68960 +] & BT7		653190		653191	653192		
10	Tonneau: RHD: Mohair - BJ7 & BJ8		703144		703145	703146		
11	Hood Frame Cover - BJ7 & BJ8		703160	703161	703162	703163	703164	703169
11	Hood Frame Cover - Duck: BJ7 & BJ8		703170					
11	Hood Frame Cover - Mohair: BJ7 & BJ8		703174		703175	703176		
12	Hood Webbing: BJ7 & BJ8		703190			703191		
07	Tonneau: LHD: BN4 [to 68959]		653150	653151	653152	653153		652159
09	Tonneau: LHD: BN4 [68960 +] & BT7		653183	653184	653185	653186		653187
10	Tonneau: LHD: BJ7 & BJ8		703130	703131	703132	703133	703134	703139
07	Tonneau: LHD: Duck - BN4 [to 68959]		653170					
09	Tonneau: LHD: Duck - BN4 [68960 +] & BT7		653193					
10	Tonneau: LHD: BJ7 & BJ8		703150					
09	Tonneau: LHD: Mohair - BN4 [68960 +] & BT7		653195		653196			
10	Tonneau: LHD: Mohair - BJ7 & BJ8		703154		703155			

We are always happy to help you decide on the interior colour scheme of your classic car. We can offer advice & supply material and colour samples. (it would help to know the exterior paint colour(s) and the interior colour(s) you prefer). To see a selection of the colours currently available please refer to the Colour & Trim Reference page of this catalogue.

Seat & Carpet Parts: As a manufacturer we are able to make and supply individual seat and carpet parts. But please note that there may be colour differences between your existing parts and the new parts supplied due to the effect of general use, light and aging. Any individual parts ordered will be made to special order.

JOHN SKINNER (MANUFACTURING) LTD, is a recognised supplier of the British Austin-Healey Club.

**World wide Export Service
Request**









Trim Available in Leather & Vinyl

Samples Available on

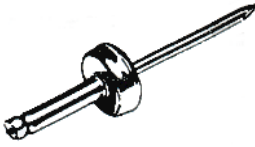



Trim Fittings BN1 to BJ8

<p><i>Stud with Flange - 011402</i></p> 	<p><i>Stud No Flange -</i></p> 	<p><i>Blind Rivet (Pop) - 011410</i></p> 	<p><i>Seat Clip - 011412</i></p> 
<p><i>Button: Silver</i></p> 	<p><i>Socket</i></p> 	<p><i>Seat Clip : Tube Type -</i></p> 	<p><i>Trim Clip - 051402</i></p> 
<p><i>Carpet Clip: Pronged Ring</i></p> 	<p><i>Carpet Clip: Clinch Plate</i></p> 	<p><i>Lift The Dot :Socket - 011414</i></p> 	<p><i>Lift The Dot :Clinch Plate - 011414</i></p> 
<p><i>Button : Black</i></p> 	<p><i>Socket</i></p> 		
<p><i>Tenax - Button</i></p> 	<p><i>Tenax - Plate</i></p> 		

We are always happy to help you decide on the interior colour scheme of your classic car. We can offer advice & supply material and colour samples. (it would help to know the exterior paint colour(s) and the interior colour(s) you prefer). To see a selection of the colours currently available please refer to the Colour & Trim Reference page of this catalogue.

Seat & Carpet Parts : As a manufacturer we are able to make and supply individual seat and carpet parts. But please note that there may be colour differences between your existing parts and the new parts supplied due to the effect of general use, light and aging. Any individual parts ordered will be made to special order.

JOHN SKINNER (MANUFACTURING) LTD, is a recognised supplier of the British Austin-Healey Club.

**World wide Export Service
Request**

Trim Available in Leather & Vinyl

Samples Available on





Trim Fittings BN1 to BJ8

Ref No	Description	
	<i>Trim Panel Fixing Kit – BN1 to BJ7</i>	633201
	<i>Carpet Fixing Kit – All Models</i>	633210
	<i>Trim Panel Fixing Kit – BJ8</i>	713201
	<i>Common Sense Fastener - Eyelet</i>	633211
	<i>- Plate</i>	633212

We are always happy to help you decide on the interior colour scheme of your classic car. We can offer advice & supply material and colour samples. (it would help to know the exterior paint colour(s) and the interior colour(s) you prefer). To see a selection of the colours currently available please refer to the Colour & Trim Reference page of this catalogue.

Seat & Carpet Parts: As a manufacturer we are able to make and supply individual seat and carpet parts. But please note that there may be colour differences between your existing parts and the new parts supplied due to the effect of general use, light and aging. Any individual parts ordered will be made to special order.

JOHN SKINNER (MANUFACTURING) LTD, is a recognised supplier of the British Austin-Healey Club.

**World wide Export Service
Request**

Trim Available in Leather & Vinyl

Samples Available on

